

Inductive Sensors
BES 516-366-G-E4-Y-03
M18x1 x 36
normally-open
Sn=8mm
shielded

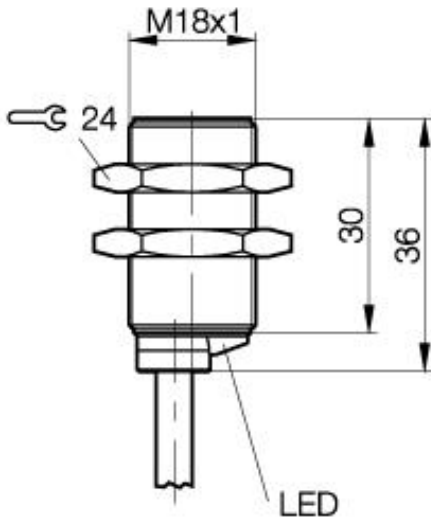

PX0143

Common Data

Mounting in steel	shielded
Rated operating distance Sn	8mm
Assured operating distance Sa	0...6.4mm
Repeatability R	≤ 5%
Hysteresis	≤ 15%
Function indication	yes
Ambient temperature range	-25...+70°C
Pollution Degree	3
Time delay before availability	≤ 10ms

Mechanical Data

Measurements BxHxT or DxT	M18x1 x 36mm
Housing material	Nickel plated brass
Material of sensing face	PBTP
Degree of protection	IP68 acc. BWN Pr 20IP
Connection	Cable
Cable type	LiYY-O
Schock: Halfsinus, 30 gn, 11ms	
Vibration: 55 Hz, 1mm Amplitude, 3 x 30 Minutes	

Electrical Data

Current type	DC
Wiring	3-Wire
switching function	normally-open
Output signal	NPN
Rated operational voltage	24 DCV
Rated operational current	130mA
Supply voltage	10...30 DCV
Ripple	≤ 15%
max. switching frequency	200Hz
No-load supply current	≤ 12/≤ 25mA
Off-state current	≤ 80µA
Voltage drop	≤ 3.5/-V
Short circuit protection	yes
Protected against polarity reversal	yes

Remarks

Mounting Instructions 825357

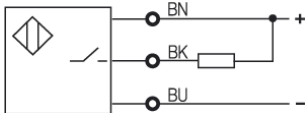

Utilization categories
 Insulation class

DC 13

Datasheet number:

Definitions see general catalog.
 If not otherwise noted, ratings according to
 IEC 60947-5-2 (DIN EN60947-5-2)

Balluff GmbH
 Schurwaldstrasse 9
 73765 Neuhausen a.d.F.
 Phone (07158) 173-0 Fax (07158) 5010

Datenblatt by CD-ROM - 04/2007

BALLUFF
 sensors worldwide